

Small Incision - Optimal Exposure

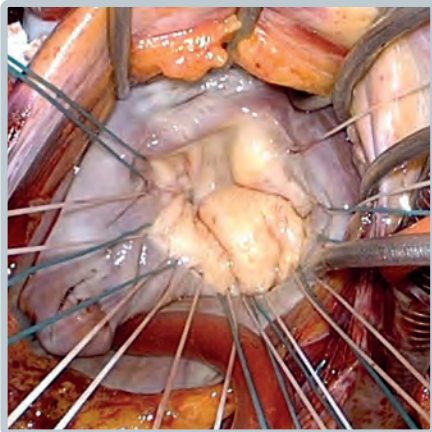

Adams Retractor

Adams Retractor



"The lateral displacement system optimizes the working mitral access area without the need for additional sternal spreading."

Dr. David Adams

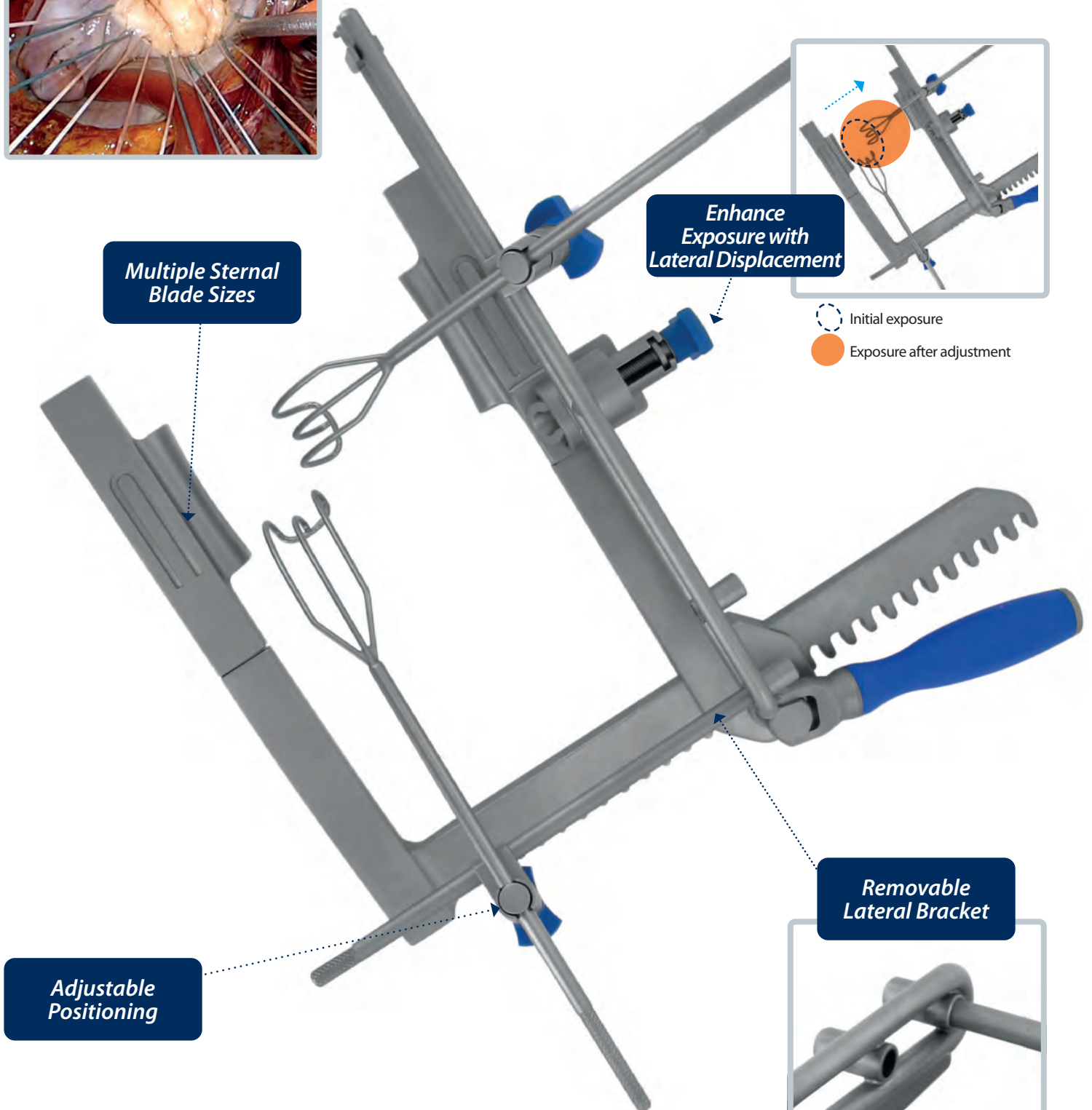

Multiple Sternal Blade Sizes

Enhance Exposure with Lateral Displacement

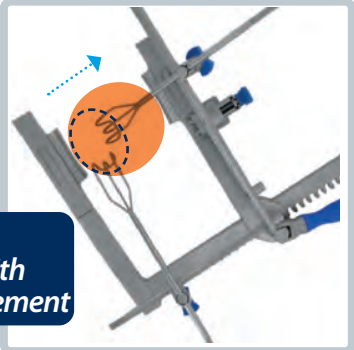

○ Initial exposure
● Exposure after adjustment

Adjustable Positioning

Removable Lateral Bracket



Two positions

DC30150-01



Adams Retractor (Rack Down)

- ✗ Dimensions: c: 190 mm - d: 180 mm
- ✗ Rack-up also available: DC30150-02
- ✗ Included with sternal retractor:
 - 3 attachment brackets for hook



- 3 pairs of sternal blades with adaptor



a: 50 mm - b: 30 mm

a: 50 mm - b: 40 mm

a: 70 mm - b: 40 mm

- 1 sternal blade without adaptor (use as standard sternal retractor)



a: 50 mm - b: 40 mm

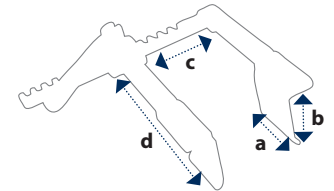

Adams Mitral Hooks Set

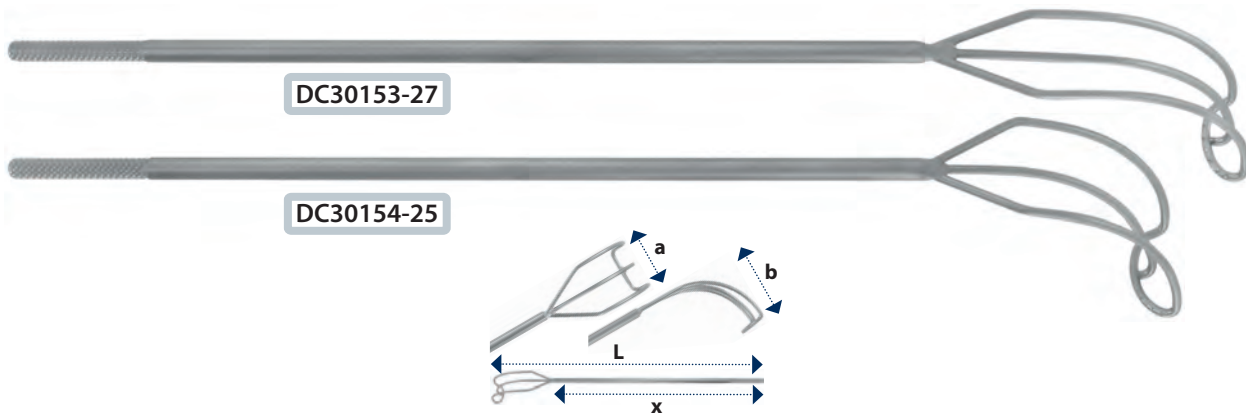

DC30153-27

DC30154-25

2 x DC30153-27

Adams long and thin hook

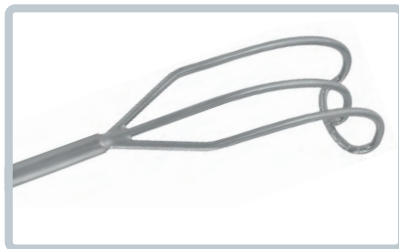

a: 20 mm - b: 34 mm

L: 270 mm - x: 200 mm

+ 1 x DC30154-25

Adams medium hook

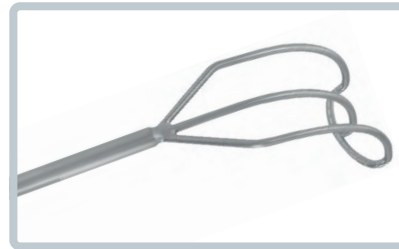

a: 26 mm - b: 34 mm

L: 250 mm - x: 200 mm

All the hooks available

Adams long and thin hook

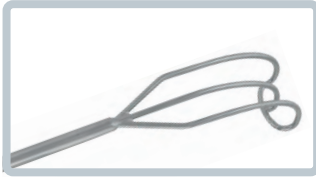

a: 20 mm - b: 34 mm

DC30153-22

L: 220 mm - x: 150 mm



DC30153-27

L: 270 mm - x: 200 mm

Large hook



a: 35 mm - b: 34 mm

DC30155-20

L: 200 mm - x: 150 mm



DC30155-25

L: 250 mm - x: 200 mm

Adams medium hook



a: 26 mm - b: 34 mm

DC30154-20

L: 200 mm - x: 150 mm



DC30154-25

L: 250 mm - x: 200 mm

Tricuspid hook

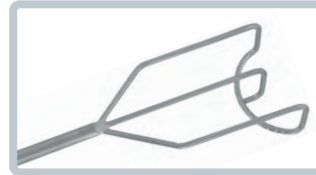

a: 35 mm - b: 16 mm

DC30156-22

L: 220 mm - x: 150 mm



DC30156-27

L: 270 mm - x: 200 mm

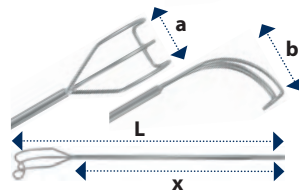

Adams Recommended Set



DC30150-01

Adams retractor



2 x DC30153-27

Adams long and thin hook



+ 1 x DC30154-25

Adams medium hook

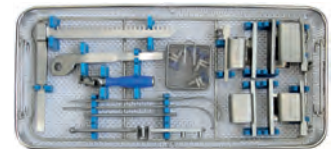

1 x DC30159-00

Large basket with lid (540 x 240 x 100 mm)
For Adams retractor and three hooks
Instruments not included

Delacroix-Chevalier
Paris

Corporate Office
13. Avenue de la République - 75011 Paris - France

Manufacturing and logistic
Rue Renée et Louis Landanger
52000 Chaumont - France

Phone : +33 (0) 3 25 02 10 35 - Fax : +33 (0) 3 25 02 10 20

Email : export@delacroix-chevalier.com www.delacroix-chevalier.com

© Copyright 2009-2015 / The photos and pictures are not contractual. Patterns are subject to change.

